

# Grease Interceptor

## Above Ground

**Thin-Skin**

**Page 2-4**

**Paneltim<sup>®</sup>**

**Page 5-7**

© 2016

---

**Tel: 03 9587 2297**

Viking Plastics Engineering Pty Ltd. 143 Woodlands Drive Braeside, Victoria 3195  
Fax: 03 9587 1172 | [info@vikingplastics.com.au](mailto:info@vikingplastics.com.au) | [www.vikingplastics.com.au](http://www.vikingplastics.com.au)



- > above-ground installation.
- > required in commercial food preparation areas.
- > the function of a grease trap is to slow the flow of warm/hot greasy water thus allowing it to cool. As the water cools, the grease and oil separate and float to the top, solids to settle on the bottom of the tank and the cleaner/cooler water flows out to sewer.

## Above-ground

Capacity litres	External Tank Dimensions mm			
	Length	Width	Water	Height
100	600	400	400	600
150	700	470	470	670
200	800	500	500	700
250	900	530	530	730
250a	1200	530	400	600
300	1120	600	450	750
350	1120	600	530	820
400	1250	600	550	850
500	1250	750	550	850
600	1250	750	660	960
700	1250	750	770	1070
750	1500	750	680	980
800	1500	750	730	1030
900	1500	900	680	980
1000	1500	900	760	1060
1100	1500	900	830	1130

## Sizes over 1100lt supplied in Paneltim

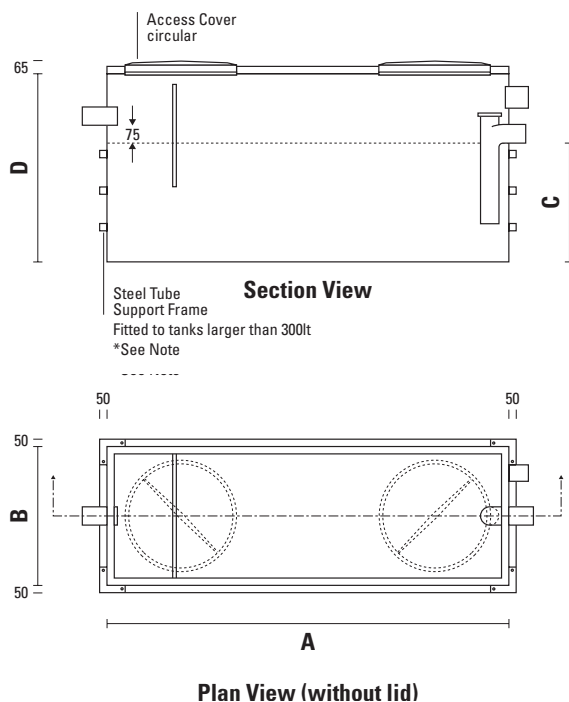

## Grease Trap (Interceptor) model VP9-2

For above-ground installations

- > Manufactured from PVC and Polypropylene (PP) materials, this tank is suitable for above-ground installations only
- > Standard tanks are fitted with 100mm nb. Inlet Outlet and Vent
- > Circular screw-in access covers are fitted to the top lid that is screw fixed to the tank flange
- > Tank dimensions and pipe positions conform to Trade Waste recommendations but may be arranged to suit the installation requirement
- > When space limitations dictate, equivalent capacity tanks can be manufactured to order
- > \*Note: Tanks larger than 250 litres capacity have external steel support frame fitted. Allow 50mm all round
- > External tank height dimension (D) does not include height of lids (65mm)

# Typical Above Ground Tank installation

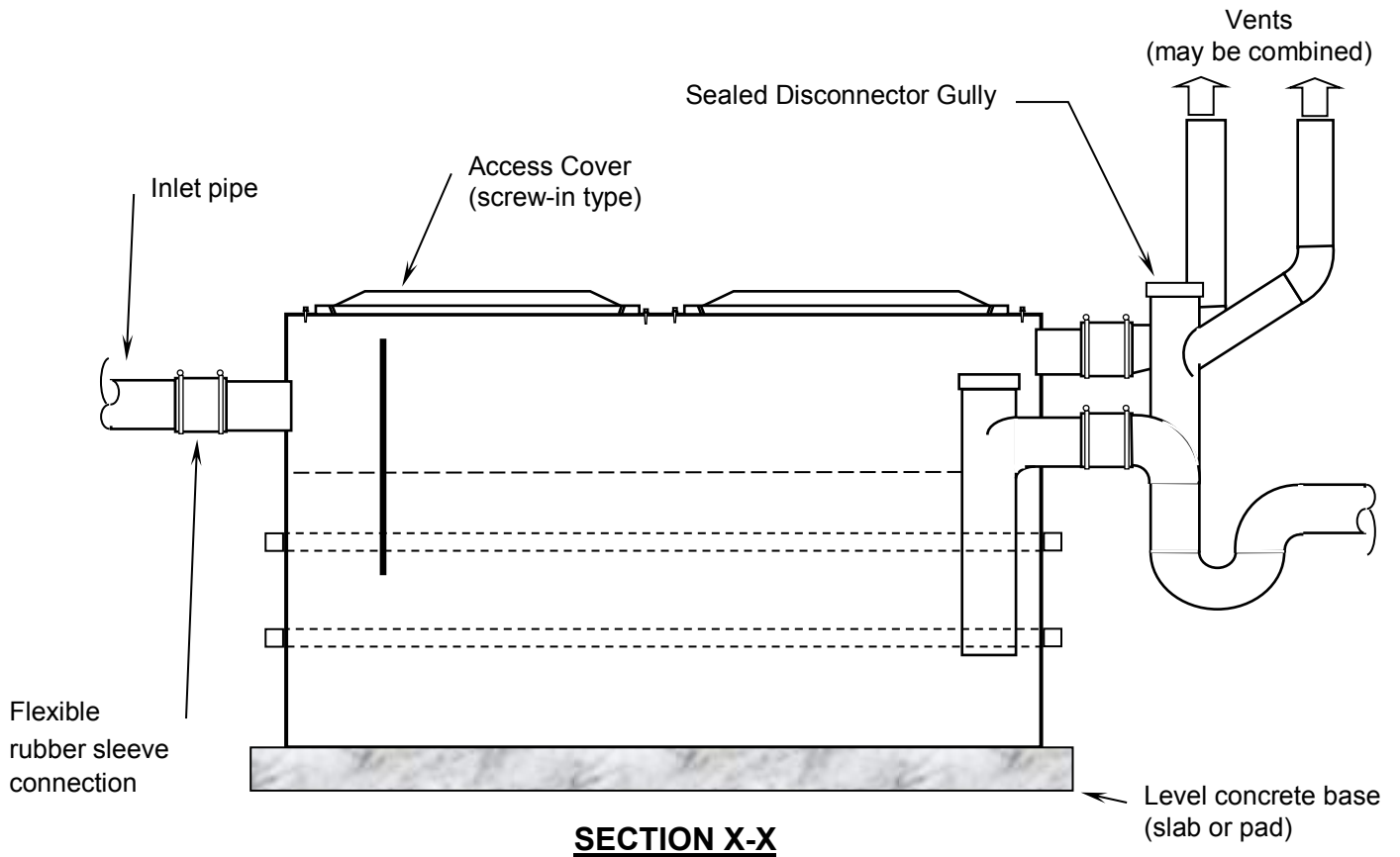

**NOTE:** Baffle and internal pipe configurations vary according to tank type capacity and/or customer requirements. All attempts should be made to ensure external connections correspond as close as possible to these drawings.

Installation and approval conditions may vary from region to region. This information is provided as a guide only for a typical above-ground tank installation. The pipe connection diagram is for indicative purposes only. Viking Plastics reserves the right to alter or change information at any time and without notice.

# **INSTALLATION & CLEANING GUIDELINES**

## **ABOVE GROUND TANKS**

The information provided herein is informative only and it applies to the above-ground installation of plastic fabricated Trade Waste Pre-Treatment Tanks. As rules and regulations differ from region to region, prior to proceeding we recommend the installing person verify that the procedures mentioned in this document satisfy the requirements of the local Authorities.

**Trade Waste Authorities state that above-ground tanks must be installed on a level concrete pad.**

**Any portion of a tank installed below ground should be surrounded with a minimum of 100mm thick concrete – walls and base.**

### **Siting Considerations**

1. The tank should be located as close as practical to the source of contaminated water.
2. Ensure ease of accessibility for maintenance.
3. A water tap for the purpose of wash-down should be located nearby and must be fitted with backflow prevention device.
4. Grease Traps should not be installed in direct sunlight.

### **Site Preparation**

5. Verify that inlet, outlet and vent pipe levels match the level of the pipe spigots on the tank.
6. If not already in place pour or install a level concrete pad for the tank to sit on. The concrete should be a minimum of 28mpa. Tanks in excess of 2000lt should have a pad at least 100mm thick.
7. The concrete slab or pad must support the entire length and width of the tank.
8. Do not remove the steel support frame (if fitted) from the tank.
9. If the tank is installed in an area exposed to vehicle traffic, bollards should be positioned to protect the tank.

### **Connections**

10. Connections to be in accordance with Trade Waste and Plumbing Industry Commission guidelines and to comply with ASNZ3500.2.
11. The Trade Waste department of the local water authority must approve all grease trap and trade waste interceptor installations prior to work commencing. Interceptors installed without approval may not be accepted for use.

### **Grease Trap Cleaning**

12. Clean outs to be performed in accordance with the trade waste agreement with your local water authority.
13. The contractor is to un-screw the screw-in access cover (if fitted).
14. Contents to be pumped out via the suction hose attached to the pump truck.
15. With the suction hose still inside the tank chamber the entire internal surface is to be hosed down to remove residual grease build up.
16. Tank walls may be scrapped down to remove any solid accumulation.
17. Lid seals should be wiped clean, the seal checked for integrity and the screw-in access covers replaced or clamp down lids reinstalled.

# Above-Ground Paneltim® Tanks

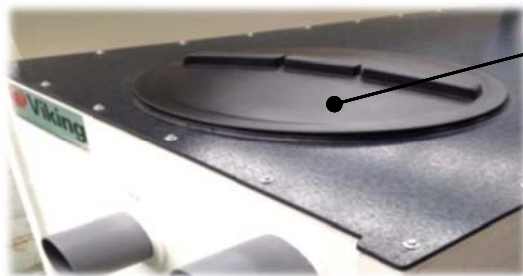
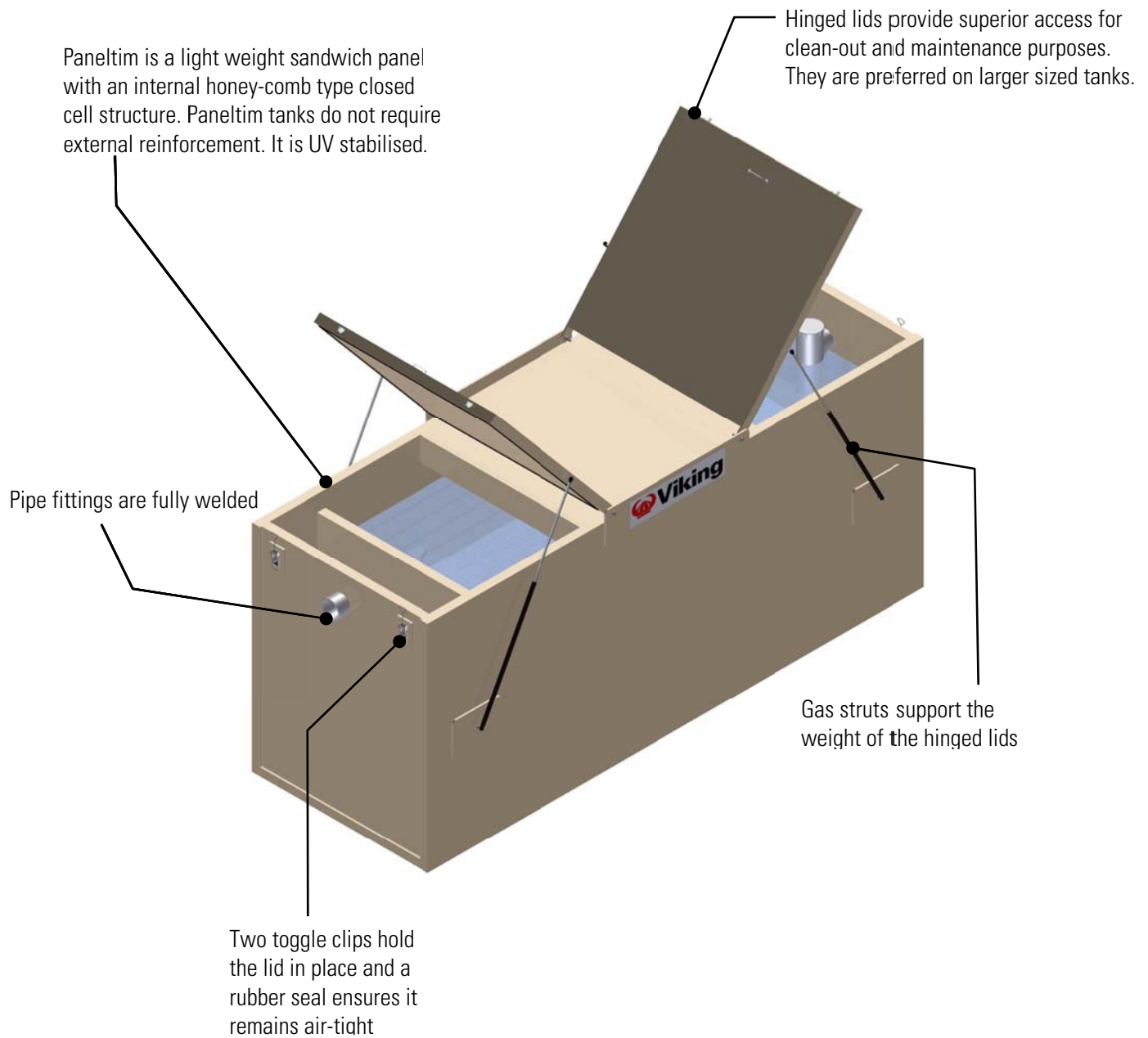

Circular access covers are available on tanks up to 4000lt capacity. They are easily removable and provide an air-tight seal

Tel: 03 9587 2297

Viking Plastics Engineering Pty Ltd. 143 Woodlands Drive Braeside, Victoria 3195  
Fax: 03 9587 1172 | [info@vikingplastics.com.au](mailto:info@vikingplastics.com.au) | [www.vikingplastics.com.au](http://www.vikingplastics.com.au)



# Grease Interceptor - Paneltim® Viking

Above-Ground

VPT9-2

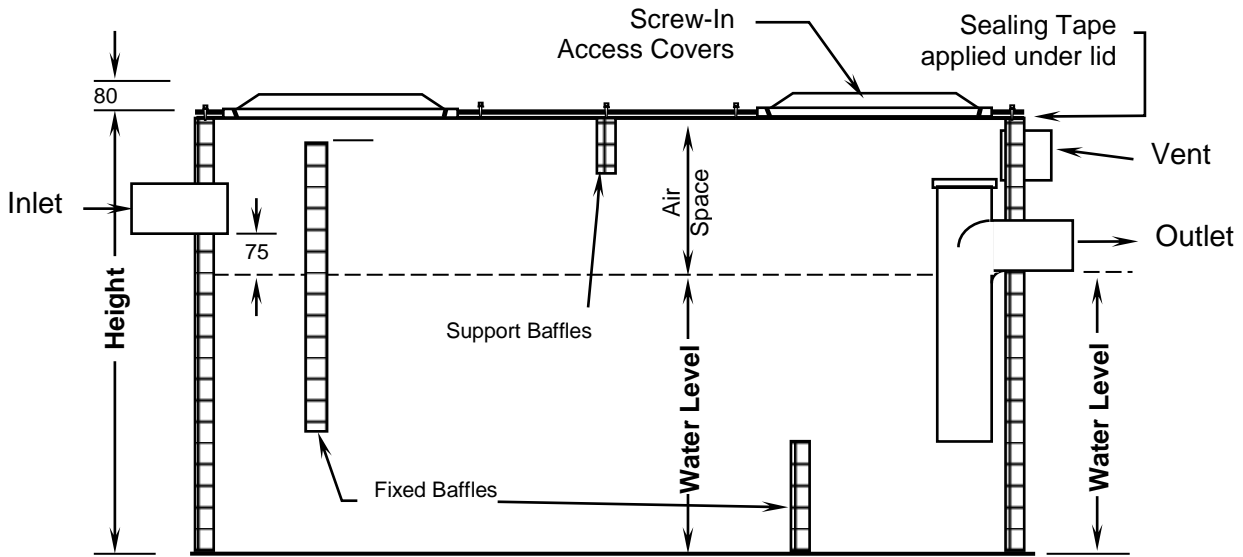

**SECTION X-X**

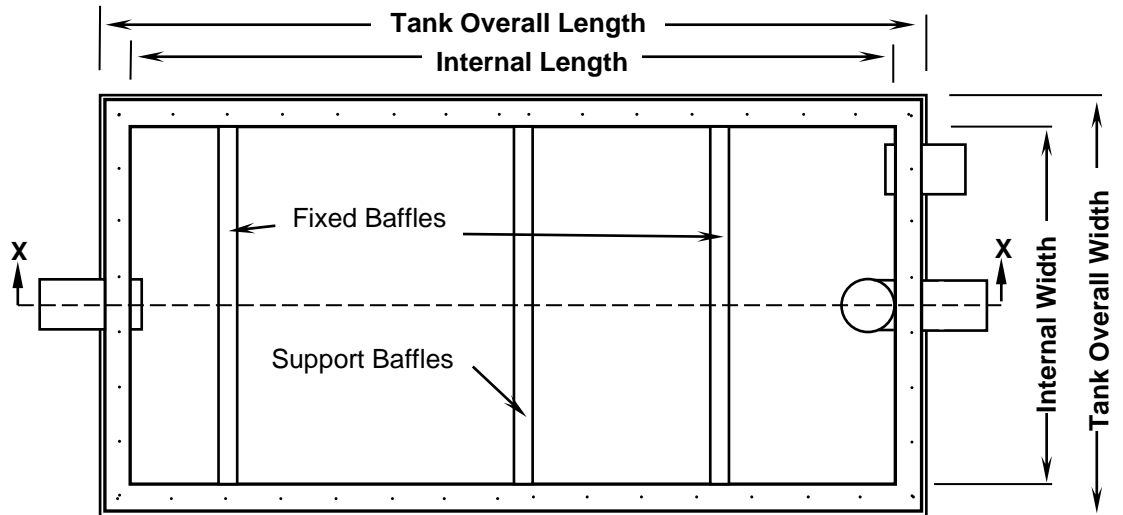

**PLAN VIEW**  
(shown without lids)

**NOTES:**

- The interceptor, including baffles, is constructed of **Paneltim construction panel**.
- Pipe nozzles are Polypropylene.
- If installed externally, the tank must be protected from direct sunlight.
- The interceptor is to be installed in a position that provides ready access for maintenance, inspection and cleaning purposes.
- The relevant authority must approve the proposed location of a grease interceptor prior to its installation.
- A program for regular maintenance and cleaning should be established with an authorised waste collection contractor.
- The tank depicted conforms to approved design drawings for regions of VIC, TAS, WA and some areas of QLD and NSW. For installations in other areas, including regions governed by Sydney Water, we recommend the appropriateness of the tank design and its proposed location be verified for use by the local Authority prior to order placement.

**Dimensions (mm)**

Model	Capacity (litres)	Internal Dimensions				Overall Dimensions			Inlet dia	Outlet dia	Vent dia	Air Space
		Length	Width	Water	Height	Length	Width	Height				
(Feb 2016)												
<b>PT9-2-600</b>	600	1250	740	660	960	1390	860	1030	100	100	50	300
<b>PT9-2-1000</b>	1000	1500	880	760	1060	1640	1000	1120	100	100	100	300
<b>PT9-2-1500</b>	1500	2000	900	830	1130	2140	1030	1140	100	100	100	300
<b>PT9-2-2000</b>	2000	2200	900	1000	1300	2340	1030	1310	100	100	100	300
<b>PT9-2-2500</b>	2500	2800	900	1000	1300	2940	1030	1310	100	100	100	300

Viking Plastics Engineering Pty Ltd  
143 Woodlands Drive, Braeside Vic 3195

For further information call:

# Grease Interceptor - Paneltim®



Above-Ground

VPT9-2

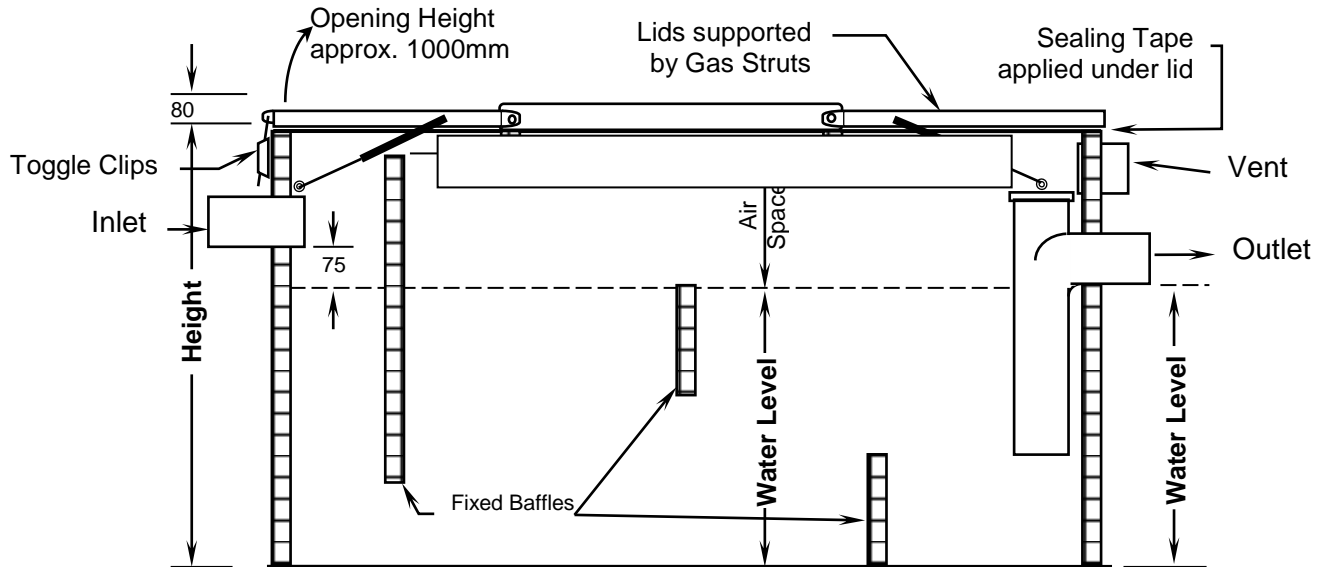

**SECTION X-X**

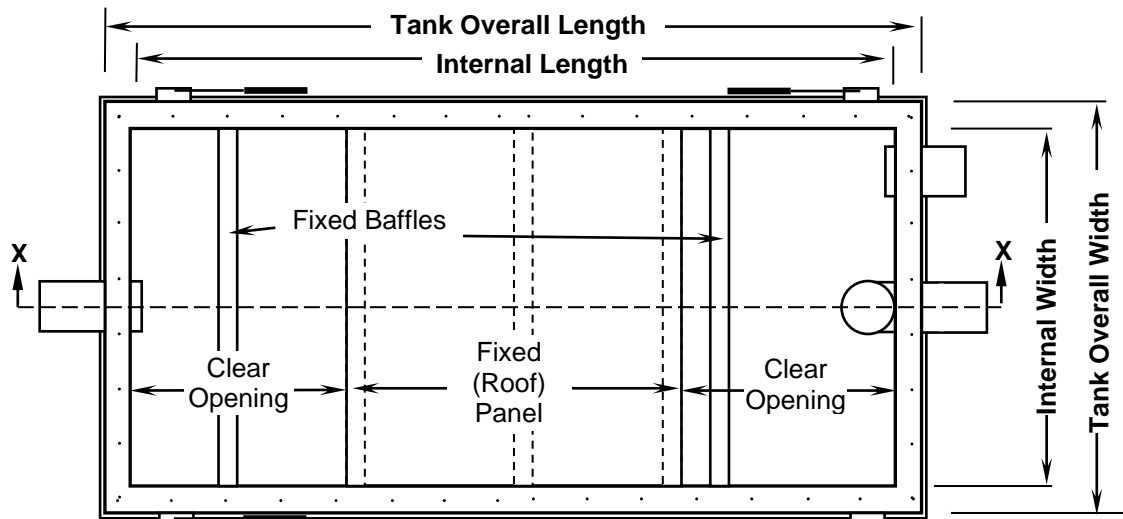

**PLAN VIEW**

(shown without lids)

**NOTES:**

- The interceptor, including baffles, is constructed of **Paneltim construction panel**.
- Hinged lids with gas strut supports (as depicted) provide maximum access. Circular screw-in covers in a fixed lid are an optional alternative.
- Pipe nozzles are Polypropylene.
- If installed externally, the tank must be protected from direct sunlight.
- The interceptor is to be installed in a position that provides ready access for maintenance, inspection and cleaning purposes.
- The relevant authority must approve the proposed location of a grease interceptor prior to its installation.
- A program for regular maintenance and cleaning should be established with an authorised waste collection contractor.
- The tank depicted conforms to approved design drawings for regions of VIC, TAS, WA and some areas of QLD and NSW. For installations in other areas, including regions governed by Sydney Water, we recommend the appropriateness of the tank design and its proposed location be verified for use by the local Authority prior to order placement.

**Dimensions (mm)**

Model	Capacity (litres)	Internal Dimensions				Overall Dimensions (base)			Inlet dia	Outlet dia	Vent dia	Air Space
		Length	Width	Water	Height	Length	Width	Height				
(Feb 2016)												
<b>PT9-2-3000H</b>	3000	3000	1000	1000	1300	3140	1130	1310	100	100	100	300
<b>PT9-2-4000H</b>	4000	3000	1350	1000	1300	3140	1480	1310	100	100	100	300
<b>PT9-2-5000H</b>	5000	3000	1500	1120	1420	3140	1630	1430	100	100	100	300
<b>PT9-2-7500H</b>	7500	3600	1800	1200	1500	3740	1930	1510	150	150	100	300
<b>PT9-2-10000H</b>	10000	4000	2000	1250	1550	4140	2130	1560	150	150	100	300

Viking Plastics Engineering Pty Ltd  
143 Woodlands Drive, Braeside Vic 3195

For further information call: